

Snitt B-B, post

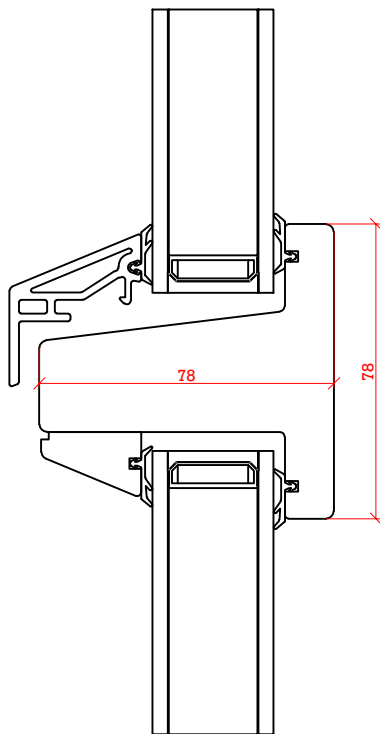

Snitt A-A, losholt

Tegning nr: GSD-T-HV0401

Rev.nr: 0

Rev. dato 26.03.2019

Tegnet av: SD

Godkjent: ***



Lian Trevarefabrikk AS

Lian Heve skyvedør
Detalj post og losholt

Vert/horisontalsnitt

Målestokk 1:2

Toleranse $\pm 0,3$ mm

Forbehold om rett til endringer