

Snitt A - A

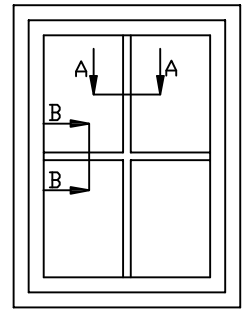

Snitt B - B

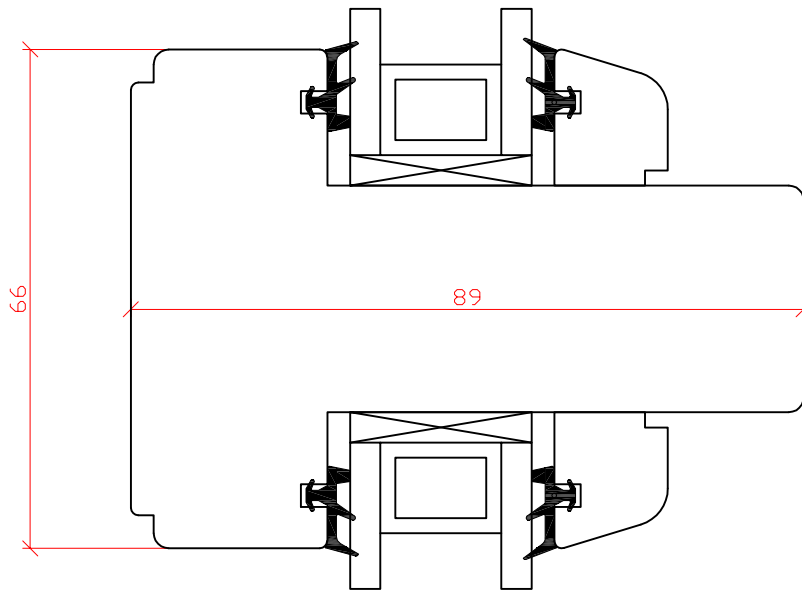
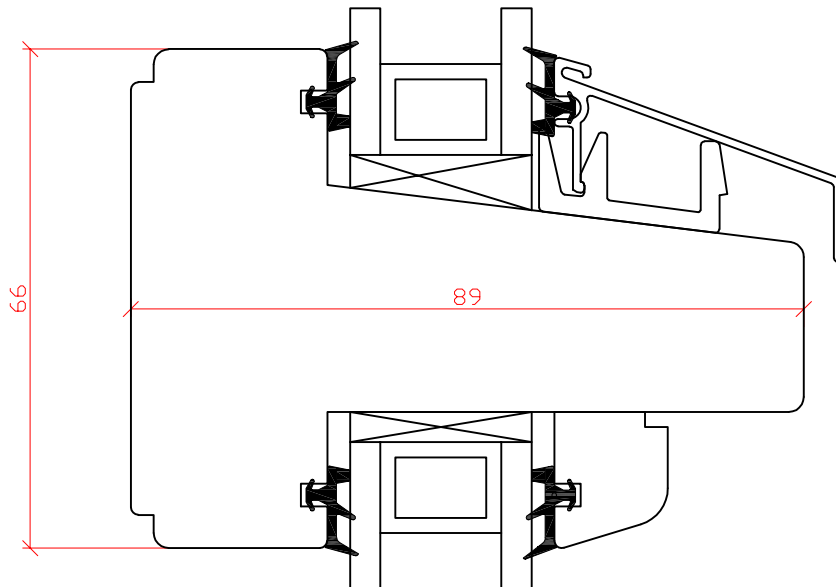

Tegning nr: SV-T-HV0401

Rev.nr: 2 (SD)

Rev. dato 02.06.2020

Tegnet av: TIS

Godkjent: JM



Lian Trevarefabrikk AS

Lian Systemvindu
Innadslående
Sprosser

Vert/horisontalsnitt

Målestokk 1:1

Toleranse $\pm 0,3\text{mm}$

Forbehold om rett til endringer